

SECTION 03

Backsplashes
Alzatine

3501

Backsplashes Alzatine

Standard backsplash.
Alzatina standard.



Accessories

Accessori

For art. 3501
Per alzatina 3501

Pack of plastic accessories.
Confezione accessori in plastica.

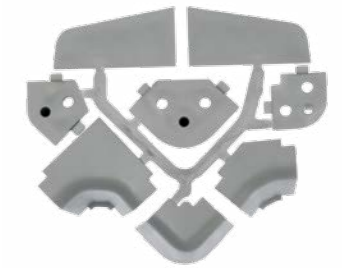

cod. 290

POSSIBLE COATINGS RIVESTIMENTI POSSIBILI

Structure: PVC support
- aluminium or PVC cover.
Finishes: paper, aluminium foil
or aluminium anodized.

Struttura: supporto in PVC
- coperchio in alluminio o PVC.
Finitura: carta, foglia alluminio
o alluminio anodizzato.

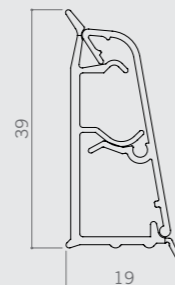

CODE CODICE	* length L lunghezza L (mm)	meters per box metri per scatola (m)	weight per box peso per scatola (kg)
3501 AL	4.000	100	33
3501	4.000	100	26

* the length of the product can be different, by request
-- su richiesta, la lunghezza del prodotto può essere diversa

MOUNTING EXAMPLE ESEMPIO MONTAGGIO

- ① right and left end cap
tappo destro e sinistro
- ② internal joint 90°
angolo interno 90°
- ③ external joint 90°
angolo esterno 90°
- ④ internal joint 135°
angolo interno 135°



for colors, see page 48
-- per i colori, vedi pagina 48

CODE CODICE	pieces per box pezzi per scatola (pcs)	weight per box peso per scatola (kg)
290	50	1

3502

Backsplashes Alzatine

Triangular backsplash.
Alzatina triangolare.



POSSIBLE COATINGS RIVESTIMENTI POSSIBILI

Structure: PVC support
- aluminium or PVC cover.
Finishes: paper, aluminium foil
or aluminium anodized.

Struttura: supporto in PVC
- coperchio in alluminio o PVC.
Finitura: carta, foglia alluminio
o alluminio anodizzato.

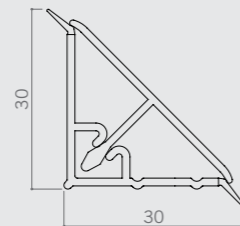

CODE CODICE	* length L lunghezza L (mm)	meters per box metri per scatola (m)	weight per box peso per scatola (kg)
3502 AL	4.000	100	35
3502	4.000	100	29

* the length of the product can be different, by request
-- su richiesta, la lunghezza del prodotto può essere diversa

Accessories Accessori

For art. 3502
Per alzatina 3502

Pack of plastic accessories.
Confezione accessori in plastica.

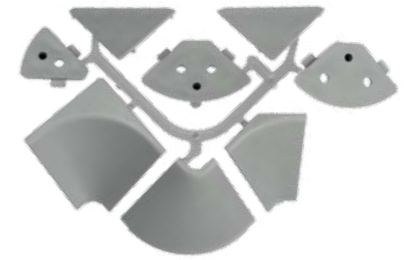

cod. 291

MOUNTING EXAMPLE ESEMPIO MONTAGGIO

- ① right and left end cap
tappo destro e sinistro
- ② internal joint 90°
angolo interno 90°
- ③ external joint 90°
angolo esterno 90°
- ④ internal joint 135°
angolo interno 135°



for colors, see page 48
-- per i colori, vedi pagina 48

CODE CODICE	pieces per box pezzi per scatola (pcs)	weight per box peso per scatola (kg)
291	50	1

35026

Backsplashes Alzatine

Triangular backsplash
for insertion.

Alzatina triangolare
per inserimento.



Accessories Accessori

For art. 35026
Per alzatina 35026

Pack of plastic accessories.
Confezione accessori in plastica.

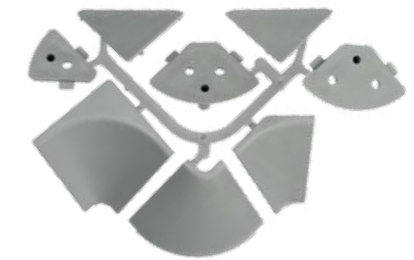

COD. 2916

POSSIBLE COATINGS RIVESTIMENTI POSSIBILI

Structure: PVC support
- transparent or grey PVC cover
predisposed for the insertion
of laminate edges.

Struttura: supporto in PVC
- coperchio in PVC trasparente
o grigio predisposto per
l'inserimento di bordi in laminato.

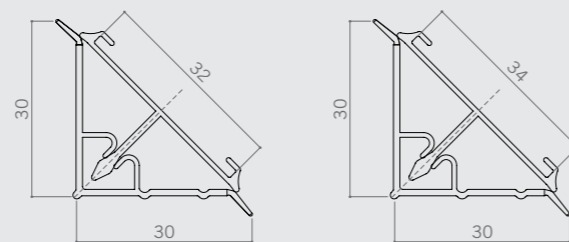

CODE CODICE	* length L lunghezza L (mm)	meters per box metri per scatola (m)	weight per box peso per scatola (kg)
35026/32	4.000	105	22
35026/34	4.000	105	22

* the length of the product can be different, by request
-- su richiesta, la lunghezza del prodotto può essere diversa

MOUNTING EXAMPLE ESEMPIO MONTAGGIO

- 1 right and left end cap
tappo destro e sinistro
- 2 internal joint 90°
angolo interno 90°
- 3 external joint 90°
angolo esterno 90°
- 4 internal joint 135°
angolo interno 135°



for colors, see page 48
-- per i colori, vedi pagina 48

CODE CODICE	pieces per box pezzi per scatola (pcs)	weight per box peso per scatola (kg)
2916	50	1

3503

Backsplashes Alzatine

Rectangular backsplash.
Alzatina rettangolare.



Accessories

Accessori

For art. 3503
Per alzatina 3503

Pack of plastic accessories.
Confezione accessori in plastica.

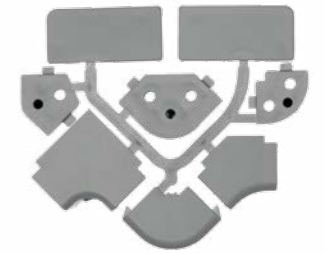

COD. 292

POSSIBLE COATINGS RIVESTIMENTI POSSIBILI

Structure: PVC support
- aluminium cover.
Finishes: paper, aluminium foil
or aluminium anodized.

Struttura: supporto in PVC
- coperchio in alluminio.
Finitura: carta, foglia alluminio
o alluminio anodizzato.

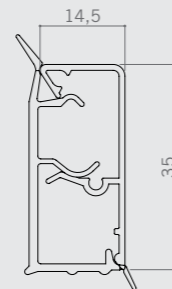

CODE CODICE	length L lunghezza L (mm)	meters per box metri per scatola (m)	weight per box peso per scatola (kg)
3503 AL	4.000	100	36
3503	4.000	100	36

MOUNTING EXAMPLE ESEMPIO MONTAGGIO

- ① right and left end cap
tappo destro e sinistro
- ② internal joint 90°
angolo interno 90°
- ③ external joint 90°
angolo esterno 90°
- ④ internal joint 135°
angolo interno 135°

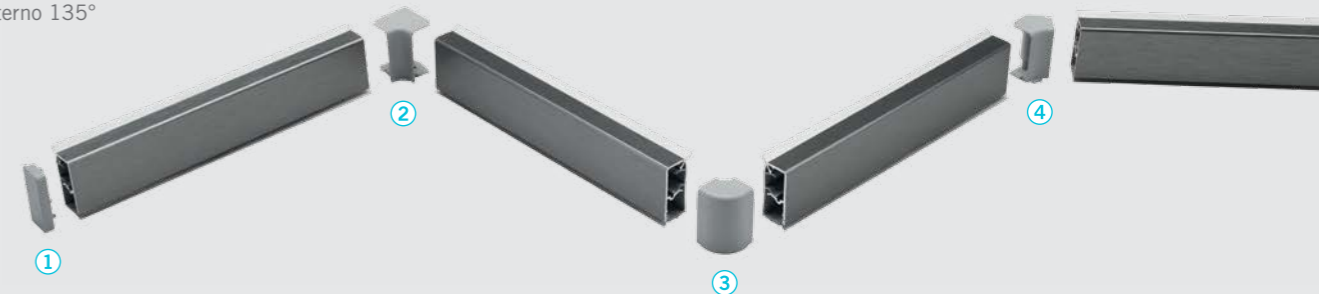

for colors, see page 48
-- per i colori, vedi pagina 48

CODE CODICE	pieces per box pezzi per scatola (pcs)	weight per box peso per scatola (kg)
292	50	1

3504

Backsplashes Alzatine

Triangular backsplash.
Alzatina triangolare.



Accessories

Accessori

For art. 3504
Per alzatina 3504

Pack of plastic accessories.
Confezione accessori in plastica.

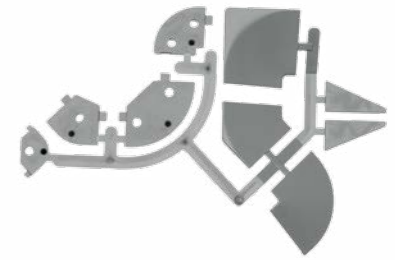

cod. 294

POSSIBLE COATINGS RIVESTIMENTI POSSIBILI

Structure: PVC support
- aluminium cover.
Finishes: paper, aluminium foil
or aluminium anodized.

Struttura: supporto in PVC
- coperchio in alluminio.
Finitura: carta, foglia alluminio
o alluminio anodizzato.

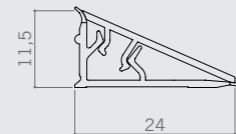

CODE CODICE	length L lunghezza L (mm)	meters per box metri per scatola (m)	weight per box peso per scatola (kg)
3504 AL	4.000	100	20
3504	4.000	100	20

MOUNTING EXAMPLE ESEMPIO MONTAGGIO

- ① right and left end cap
tappo destro e sinistro
- ② internal joint 90°
angolo interno 90°
- ③ external joint 90°
angolo esterno 90°
- ④ internal joint 135°
angolo interno 135°

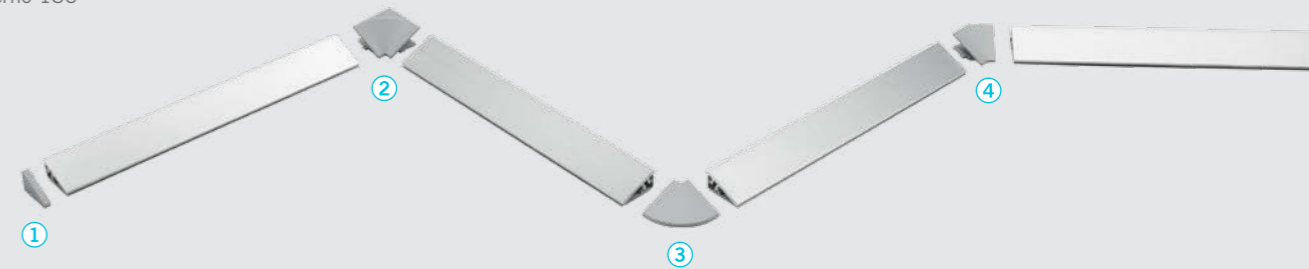

for colors, see page 48
-- per i colori, vedi pagina 48

CODE CODICE	pieces per box pezzi per scatola (pcs)	weight per box peso per scatola (kg)
294	50	1

3505 Backsplashes

Alzatine

Rectangular backsplash.
Alzatina rettangolare.

HO upstand
Alzatina OR

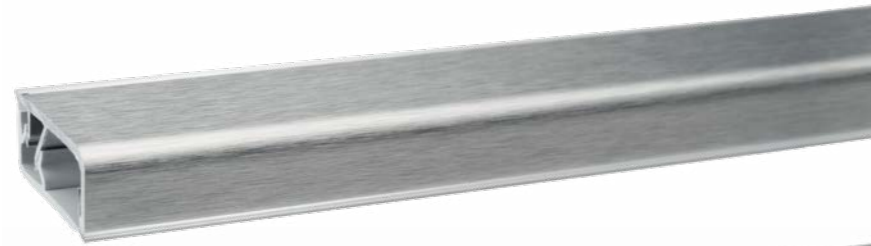

VER upstand
Alzatina VER



Accessories

Accessori

For art. 3505
Per alzata 3505

Pack of plastic accessories.
Confezione accessori in plastica.

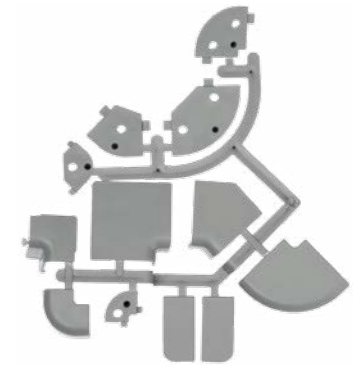

cod. 295

MOUNTING PRECAUTIONS

PRECAUZIONI DI MONTAGGIO

Accessories 295 kit includes
connectors for backsplash
mounting: OR - horizontal
+ VER - vertical

Kit accessori 295 include
giunzioni per montaggio alzata:
OR - orizzontale + VER - verticale

POSSIBLE COATINGS

RIVESTIMENTI POSSIBILI

Structure: PVC support
- aluminium or PVC cover.
Finishes: paper, aluminium foil
or aluminium anodized.

Struttura: supporto in PVC
- coperchio in alluminio o PVC.
Finitura: carta, foglia alluminio
o alluminio anodizzato.

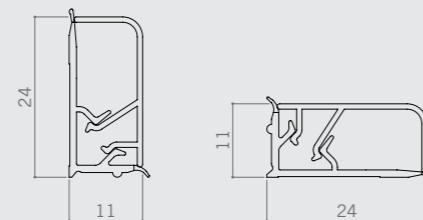

MOUNTING EXAMPLE

ESEMPIO MONTAGGIO

- ① right and left end cap
tappo destro e sinistro
- ② internal joint 90°
angolo interno 90°
- ③ external joint 90°
angolo esterno 90°
- ④ internal joint 135°
angolo interno 135°

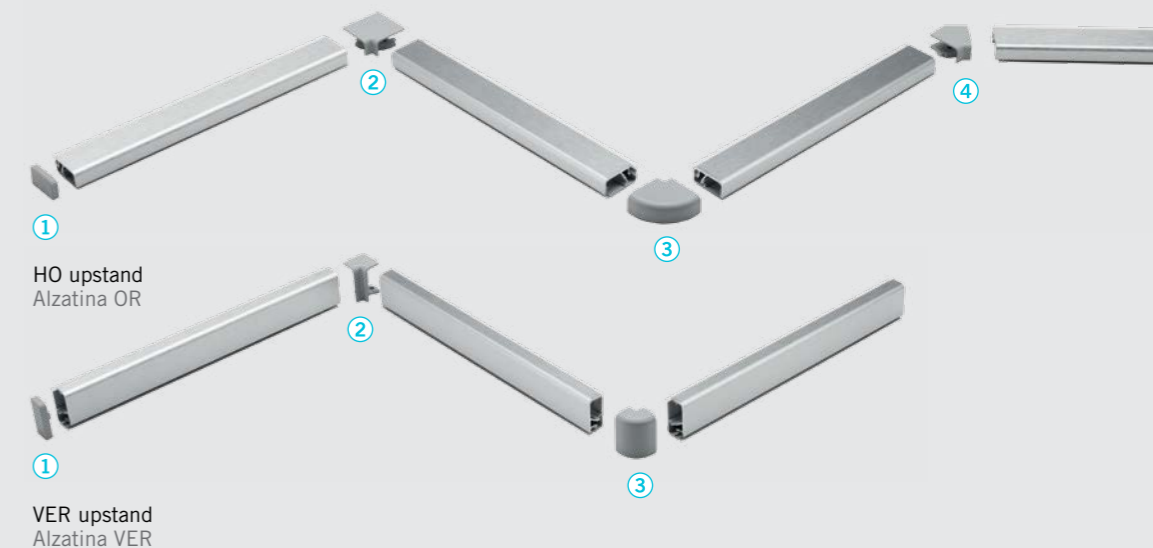

CODE CODICE	length L lunghezza L (mm)	meters per box metri per scatola (m)	weight per box peso per scatola (kg)
3505 AL	4.000	100	22
3505	4.000	100	21

for colors, see page 48
-- per i colori, vedi pagina 48

CODE CODICE	pieces per box pezzi per scatola (pcs)	weight per box peso per scatola (kg)
295	50	1

Accessories colors

Colori accessori

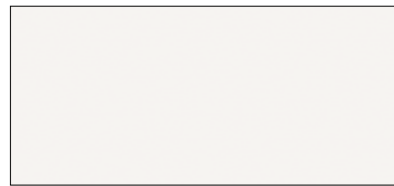

BI



GA



GR



AV



RO



NC



RC



FG



CL

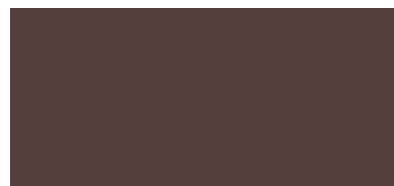

MA



VE



NR

